



# FFPF15UP20ST

## Ultrafast Recovery Power Rectifier

### Features

- Ultrafast with Soft Recovery :  $< 45\text{ns}$  ( $@ I_F = 15\text{A}$ )
- High Reverse Voltage :  $V_{RRM} = 200\text{V}$
- Avalanche Energy Rated
- Planar Construction

### Applications

- Output Rectifiers
- Switching Mode Power Supply
- Free-wheeling diode for motor application
- Power switching circuits

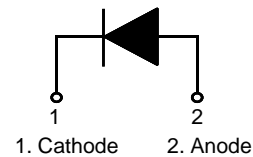
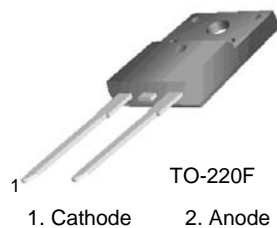

### Absolute Maximum Ratings $T_C = 25^\circ\text{C}$ unless otherwise noted

Symbol	Parameter	Value	Units
$V_{RRM}$	Peak Repetitive Reverse Voltage	200	V
$V_{RWM}$	Working Peak Reverse Voltage	200	V
$V_R$	DC Blocking Voltage	200	V
$I_{F(AV)}$	Average Rectified Forward Current @ $T_C = 105^\circ\text{C}$	15	A
$I_{FSM}$	Non-repetitive Peak Surge Current 60Hz Single Half-Sine Wave	150	A
$T_J, T_{STG}$	Operating Junction and Storage Temperature	- 65 to +150	$^\circ\text{C}$

### Thermal Characteristics

Symbol	Parameter	Max	Units
$R_{\theta JC}$	Maximum Thermal Resistance, Junction to Case	3.8	$^\circ\text{C}/\text{W}$

### Package Marking and Ordering Information

Device Marking	Device	Package	Reel Size	Tape Width	Quantity
F15UP20ST	FFPF15UP20STTU	TO-220F	-	-	50

### Electrical Characteristics T<sub>C</sub> = 25°C unless otherwise noted

Symbol	Parameter	Min.	Typ.	Max.	Units	
V <sub>FM</sub> *	I <sub>F</sub> = 15A I <sub>F</sub> = 15A	T <sub>C</sub> = 25 °C	-	-	1.15	V
		T <sub>C</sub> = 100 °C	-	-	1.0	V
I <sub>RM</sub> *	V <sub>R</sub> = 200V V <sub>R</sub> = 200V	T <sub>C</sub> = 25 °C	-	-	100	μA
		T <sub>C</sub> = 100 °C	-	-	500	μA
t <sub>rr</sub>	I <sub>F</sub> = 1A, di/dt = 100A/μs, V <sub>CC</sub> = 30V I <sub>F</sub> = 15A, di/dt = 200A/μs, V <sub>CC</sub> = 130V	T <sub>C</sub> = 25 °C	-	-	35	ns
		T <sub>C</sub> = 25 °C	-	-	45	ns
t <sub>a</sub> t <sub>b</sub> Q <sub>rr</sub>	I <sub>F</sub> = 15A, di/dt = 200A/μs, V <sub>CC</sub> = 130V	T <sub>C</sub> = 25 °C	-	13	-	ns
		T <sub>C</sub> = 25 °C	-	11	-	ns
		T <sub>C</sub> = 25 °C	-	24	-	nC
W <sub>AVL</sub>	Avalanche Energy (L = 40mH)	20	-	-	mJ	

\* Pulse Test: Pulse Width=300μs, Duty Cycle=2%

### Test Circuit and Waveforms

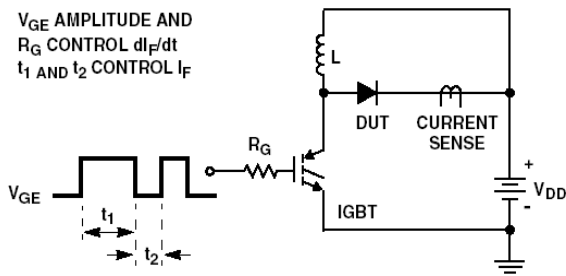

t<sub>rr</sub> TEST CIRCUIT

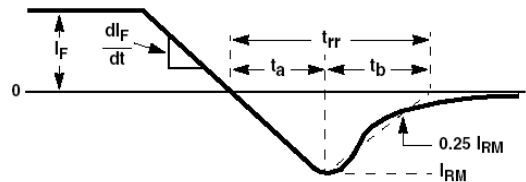

t<sub>rr</sub> WAVEFORMS AND DEFINITIONS

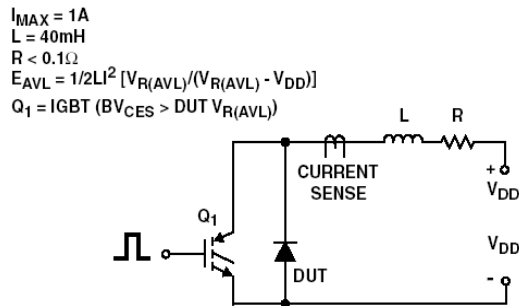

AVALANCHE ENERGY TEST CIRCUIT

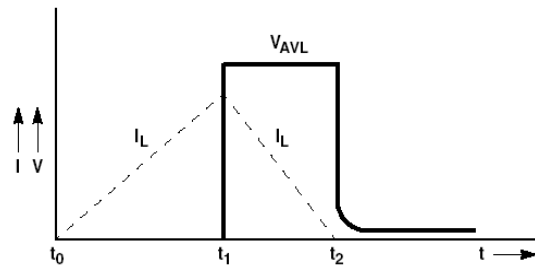

AVALANCHE CURRENT AND VOLTAGE WAVEFORMS

## Typical Performance Characteristics

Figure 1. Typical Forward Voltage Drop

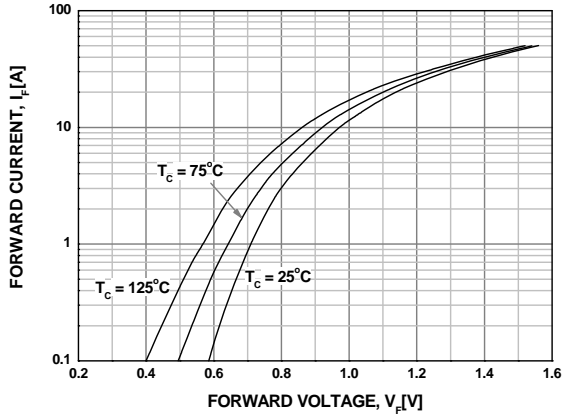

Figure 2. Typical Reverse Current

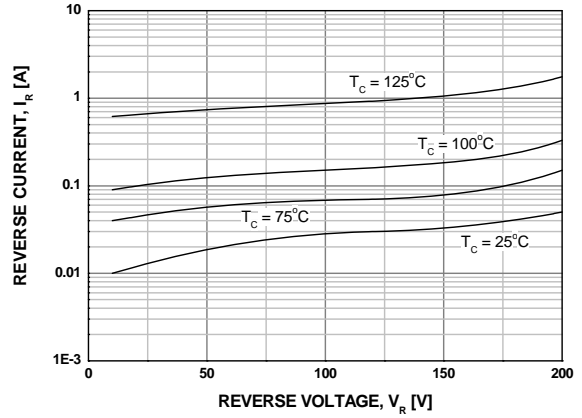

Figure 3. Typical Junction Capacitance

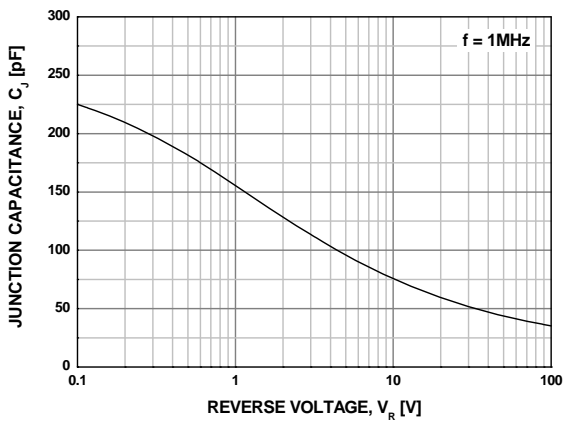

Figure 4. Typical Reverse Recovery Time

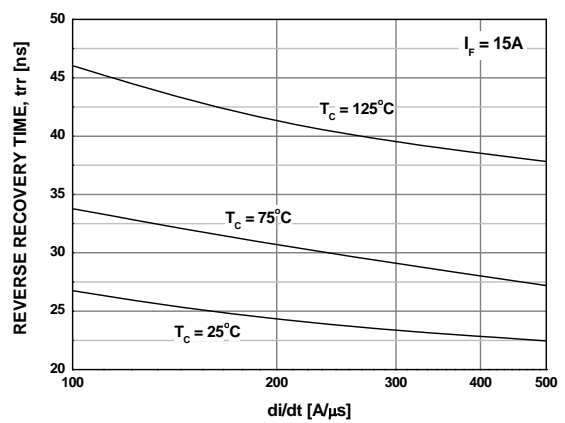

Figure 5. Typical Reverse Recovery Current

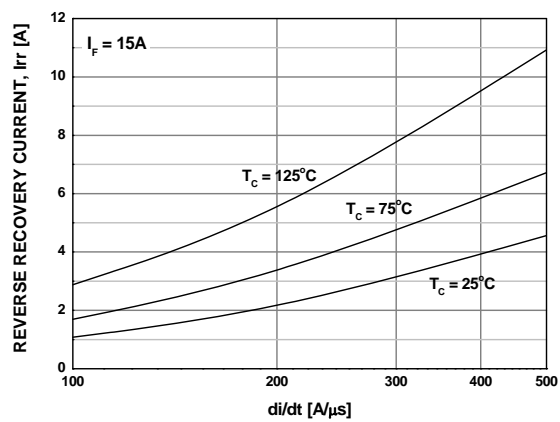
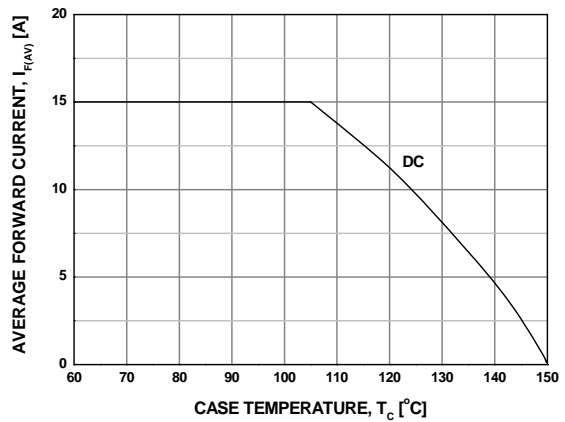
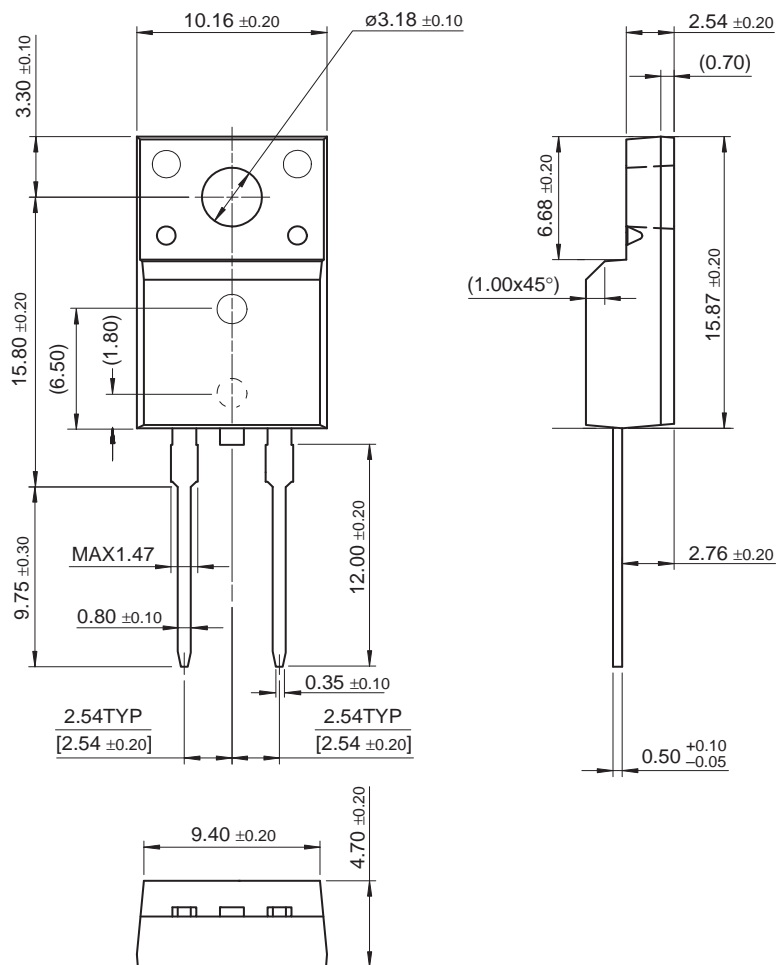

Figure 6. Forward Current Deration Curve



Package Demensions

TO-220F 2L



Dimensions in Millimeters



**TRADEMARKS**

The following includes registered and unregistered trademarks and service marks, owned by Fairchild Semiconductor and/or its global subsidiaries, and is not intended to be an exhaustive list of all such trademarks.

- |                                                                                   |                                                                                   |                                                                                   |                                                                                     |
|-----------------------------------------------------------------------------------|-----------------------------------------------------------------------------------|-----------------------------------------------------------------------------------|-------------------------------------------------------------------------------------|
| Build it Now™                                                                     | FPS™                                                                              | PDP SPM™                                                                          | The Power Franchise®                                                                |
| CorePLUS™                                                                         | F-PFS™                                                                            | Power-SPM™                                                                        | the <b>power</b>                                                                    |
| CorePOWER™                                                                        | FRFET®                                                                            | PowerTrench®                                                                      | franchise                                                                           |
| CROSSVOLT™                                                                        | Global Power Resource <sup>SM</sup>                                               | Programmable Active Droop™                                                        | TinyBoost™                                                                          |
| CTL™                                                                              | Green FPS™                                                                        | QFET®                                                                             | TinyBuck™                                                                           |
| Current Transfer Logic™                                                           | Green FPS™ e-Series™                                                              | QS™                                                                               | TinyLogic®                                                                          |
| EcoSPARK®                                                                         | GTO™                                                                              | Quiet Series™                                                                     | TINYOPTO™                                                                           |
| EfficientMax™                                                                     | IntelliMAX™                                                                       | RapidConfigure™                                                                   | TinyPower™                                                                          |
| EZSWITCH™ *                                                                       | ISOPLANAR™                                                                        | Saving our world, 1mW at a time™                                                  | TinyPWM™                                                                            |
|  | MegaBuck™                                                                         | SmartMax™                                                                         | TinyWire™                                                                           |
|  | MICROCOUPLER™                                                                     | SMART START™                                                                      |  |
| Fairchild®                                                                        | MicroFET™                                                                         | SPM®                                                                              | UHC®                                                                                |
| Fairchild Semiconductor®                                                          | MicroPak™                                                                         | STEALTH™                                                                          | Ultra FRFET™                                                                        |
| FACT Quiet Series™                                                                | MillerDrive™                                                                      | SuperFET™                                                                         | UniFET™                                                                             |
| FACT®                                                                             | MotionMax™                                                                        | SuperSOT™-3                                                                       | VCX™                                                                                |
| FAST®                                                                             | Motion-SPM™                                                                       | SuperSOT™-6                                                                       | VisualMax™                                                                          |
| FastvCore™                                                                        | OPTOLOGIC®                                                                        | SuperSOT™-8                                                                       |                                                                                     |
| FlashWriter® *                                                                    | OPTOPLANAR®                                                                       | SuperMOS™                                                                         |                                                                                     |
|                                                                                   |  | SyncFET™                                                                          |                                                                                     |
|                                                                                   |                                                                                   |  |                                                                                     |

\* EZSWITCH™ and FlashWriter® are trademarks of System General Corporation, used under license by Fairchild Semiconductor.

**DISCLAIMER**

FAIRCHILD SEMICONDUCTOR RESERVES THE RIGHT TO MAKE CHANGES WITHOUT FURTHER NOTICE TO ANY PRODUCTS HEREIN TO IMPROVE RELIABILITY, FUNCTION, OR DESIGN. FAIRCHILD DOES NOT ASSUME ANY LIABILITY ARISING OUT OF THE APPLICATION OR USE OF ANY PRODUCT OR CIRCUIT DESCRIBED HEREIN; NEITHER DOES IT CONVEY ANY LICENSE UNDER ITS PATENT RIGHTS, NOR THE RIGHTS OF OTHERS. THESE SPECIFICATIONS DO NOT EXPAND THE TERMS OF FAIRCHILD'S WORLDWIDE TERMS AND CONDITIONS, SPECIFICALLY THE WARRANTY THEREIN, WHICH COVERS THESE PRODUCTS.

**LIFE SUPPORT POLICY**

FAIRCHILD'S PRODUCTS ARE NOT AUTHORIZED FOR USE AS CRITICAL COMPONENTS IN LIFE SUPPORT DEVICES OR SYSTEMS WITHOUT THE EXPRESS WRITTEN APPROVAL OF FAIRCHILD SEMICONDUCTOR CORPORATION.

As used herein:

- Life support devices or systems are devices or systems which, (a) are intended for surgical implant into the body or (b) support or sustain life, and (c) whose failure to perform when properly used in accordance with instructions for use provided in the labeling, can be reasonably expected to result in a significant injury of the user.
- A critical component in any component of a life support, device, or system whose failure to perform can be reasonably expected to cause the failure of the life support device or system, or to affect its safety or effectiveness.

**ANTI-COUNTERFEITING POLICY**

Fairchild Semiconductor Corporation's Anti-Counterfeiting Policy. Fairchild's Anti-Counterfeiting Policy is also stated on our external website, [www.fairchildsemi.com](http://www.fairchildsemi.com), under Sales Support.

Counterfeiting of semiconductor parts is a growing problem in the industry. All manufactures of semiconductor products are experiencing counterfeiting of their parts. Customers who inadvertently purchase counterfeit parts experience many problems such as loss of brand reputation, substandard performance, failed application, and increased cost of production and manufacturing delays. Fairchild is taking strong measures to protect ourselves and our customers from the proliferation of counterfeit parts. Fairchild strongly encourages customers to purchase Fairchild parts either directly from Fairchild or from Authorized Fairchild Distributors who are listed by country on our web page cited above. Products customers buy either from fairchild directly or from Authorized Fairchild Distributors are genuine parts, have full traceability, meet Fairchild's quality standards for handling and storage and provide access to Fairchild's full range of up-to-date technical and product information. Fairchild and our Authorized Distributors will stand behind all warranties and will appropriately address and warranty issues that may arise. Fairchild will not provide any warranty coverage or other assistance for parts bought from Unauthorized Sources. Fairchild is committed to combat this global problem and encourage our customers to do their part in stopping this practice by buying direct or from authorized distributors.

**PRODUCT STATUS DEFINITIONS**

**Definition of Terms**

Datasheet Identification	Product Status	Definition
Advance Information	Formative / In Design	Datasheet contains the design specifications for product development. Specifications may change in any manner without notice.
Preliminary	First Production	Datasheet contains preliminary data; supplementary data will be published at a later date. Fairchild Semiconductor reserves the right to make changes at any time without notice to improve design.
No Identification Needed	Full Production	Datasheet contains final specifications. Fairchild Semiconductor reserves the right to make changes at any time without notice to improve the design.
Obsolete	Not In Production	Datasheet contains specifications on a product that is discontinued by Fairchild Semiconductor. The datasheet is for reference information only.